

盘式电容器/圆型陶瓷电容器 (Discoidal Ceramic Capacitor)

型号 (Model):
HLT-200035SX823M6B0

特点(Features)

- 非极化特性
- 低 ESR/ESL 电容器
- 体积小、成本低
- 稳定性高、耐压值高

(Ceramic disc capacitors are characterized by their non-polarity, low ESR/ESL, compact size, low cost, high stability, and high voltage ratings.)

应用(Application)

- 射频功率放大器、滤波器、振荡器、谐振器、阻抗匹配网络
- 去耦与旁路
- 噪声抑制与滤波作用。

(Ceramic disc capacitors are primarily used in RF power amplifiers, filters, oscillators, resonators, and impedance matching networks to perform functions such as decoupling and bypassing, as well as noise suppression and filtering.)

执行标准(Execution Standards)

- GJB192B-2011 《有失效率等级的无封装多层片式瓷介固定电容器详细规范》
(General specification for capacitors fixed multiple layer ceramic dielectric non-encapsulated capacitors with established reliability.)

环境适应性(Environmental Adaptability)

- 温度冲击: 在-55°C~125°C, 极限温度下保持 30min, 转换时间小于 1min, 循环 5 次。
(Temperature Shock: Cycle 5 times between the extreme temperatures of -55°C and 125°C. Maintain at each extreme for 30 minutes, with a transition time of less than 1 minute.)
- 高温寿命: 125°C@35VDC, 48h。
(High-Temperature Operating Life: 125°C@35VDC, 48 hours.)

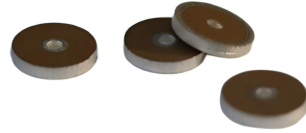

产品外型尺寸(Product Dimensions) 单位: mm(Company: mm)

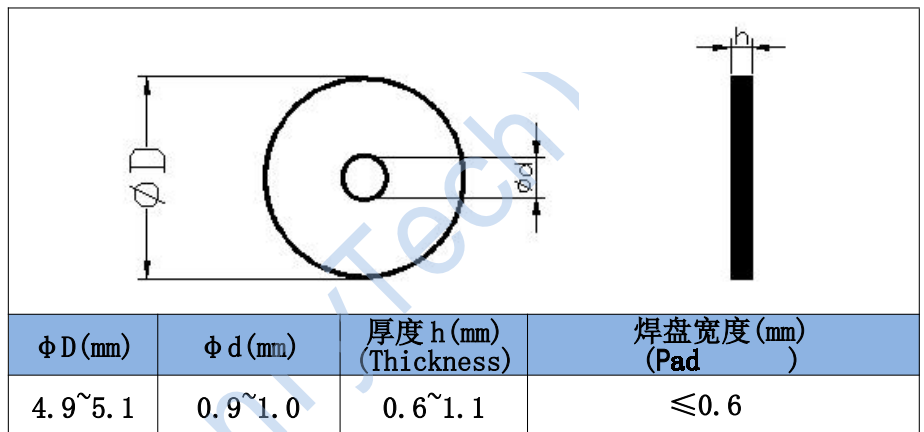

材料及性能(Materials and Properties)

项目 (listings)	参数 (Parameter)
材料 (Material)	X7R
介质损耗 (Dielectric Loss)	$\text{tg } \delta \leq 0.018 @ 1\text{KHz}$
工作温度范围 (Operation Temperature)	-55°C ~ +125°C
对地容量 (Capacitance)	82000pF
容量漂移 (Capacitance Drift)	±20%
工作电压 (WV) (Working Voltage)	25VDC
绝缘电阻 (IR) (Insulation Resistance)	$R_j \geq 15000 \text{ M}\Omega @ 100\text{VDC}$
介质耐电压 (DWV) (Dielectric Withstanding Voltage)	63VDC (测试时间 ≥ 10 sec, 无击穿和飞弧现象) (After testing at 63VDC voltage for more than 10 seconds there is no breakdown and no arc splashing phenomenon)